









13 716 782



- Ausladung 200 mm
- starrer Auslauf
- rechteckiger luftangereicherter Strahl
- Armaturenhöhe 321 mm
- Höhe bis Luftsprudler 190 mm
- Bohrungsdurchmesser 35 mm
- Rosette 60 x 60 mm
- 2x Druckschlauch M 10 x 1 eingeschraubt, dichtheitsgeprüft
- Anschluss 1/2"
- Durchfluss max. 5,7 l/min
- bleifrei
- Dieses Produkt leistet einen Beitrag zur Erfüllung der Vorgaben von nachhaltigen Gebäudezertifizierungen, z.B. LEED®, BREEAM®, DGNB

	Chrom	13 716 782-00
	Platin gebürstet	13 716 782-06
	Platin	13 716 782-08
	Dark Chrome	13 716 782-19
	Messing gebürstet (23kt Gold)	13 716 782-28
	Champagne gebürstet (22kt Gold)	13 716 782-46
	Champagne (22kt Gold)	13 716 782-47
	Dark Platin gebürstet	13 716 782-99

13 716 782

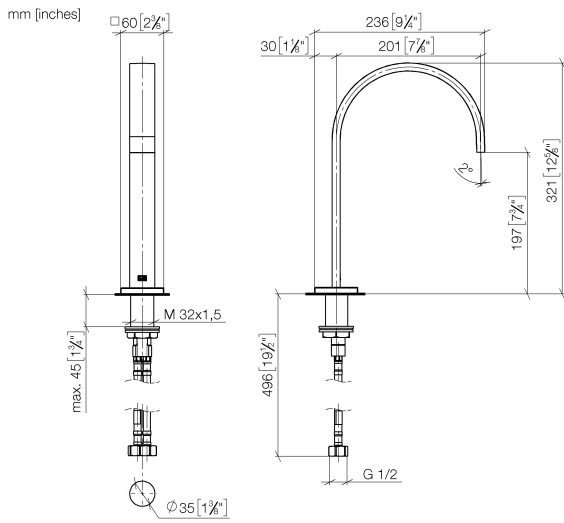

**Durchflussdiagramm**

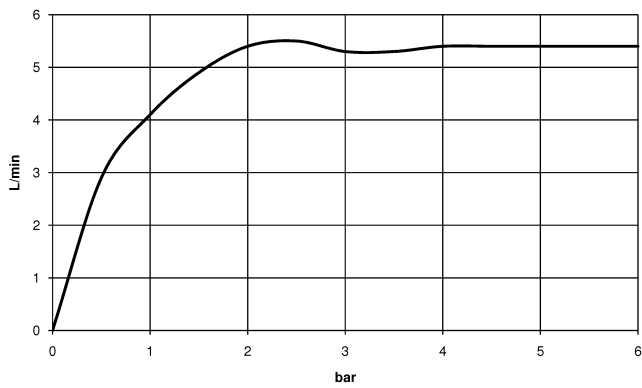

**Zertifikate**

LGA\_28441.

GDV\_0400289.

13 716 782

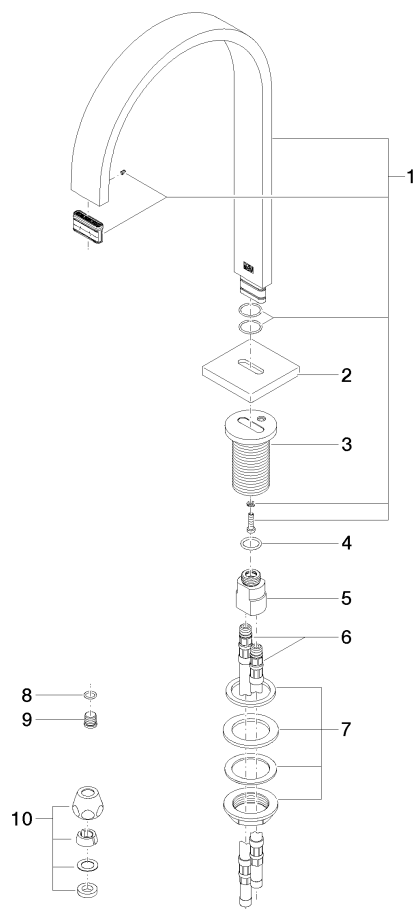

### Ersatzteilstückliste

Nr.	Artikelnummer	Benennung	Verbaumenge	Lieferzeit
1	90 28 22 155 01-00	Auslauf	1	10
2	09 27 78 034-00	Rosette	1	10
3	09 11 10 054 10 90	Anschluss	1	2
4	09 14 10 130 90	Dichtung	1	2
5	09 11 10 055 10 90	Anschluss	1	2
6	04 30 04 016 00 90	Schlauch	2	60
7	04 23 10 009 01 90	Befestigungssatz	1	2
8	90 14 10 060 00 90	Dichtung	1	2
9	09 31 20 065 90	Stopfen	1	2
10	90 23 30 040 00-00	Verschraubung	2	10